



SolarEdge ZigBee Kit Quick Installation Guide

English, Deutsch, Français, Italiano, Nederlandse

Version 1.0

Contents

English	5
SolarEdge ZigBee Kit Quick Installation Guide	5
Home Gateway User Interfaces	6
Connectors	7
DIP Switches.....	7
Configuration Button	7
LEDs	8
Installing the ZigBee Antenna and Slave Module.....	9
Home Gateway Installation	11
Installation Guidelines.....	11
Connecting the Home Gateway	11
Verifying the Connection	12
Deutsch	15
SolarEdge ZigBee Kit Schnellinstallationsanleitung	15
Home-Gateway Benutzerschnittstellen	16
Anschlüsse	17
DIP-Schalter	17
Konfigurationstaste.....	17
LEDs	18
Installieren der ZigBee-Antenne und des Slave-Moduls	19
Home-Gateway Installation	21
Installationsrichtlinien.....	21
Verbinden des Home-Gateways.....	22
Überprüfung der Verbindung.....	23
Français	25
Guide d'installation rapide du Kit ZigBee de SolarEdge	25
Interfaces d'utilisateur de la passerelle domestique	26

Connecteurs	27
Commutateurs DIP	27
Bouton de configuration	27
LEDs	28
Installation de l'antenne et du module esclave ZigBee	29
Installation de la passerelle domestique	32
Directives d'installation.....	32
Connexion de la passerelle domestique.....	33
Vérification de la connexion.....	34
Italiano.....	35
Guida rapida per l'installazione del kit ZigBee SolarEdge ...	35
Interfaccia utente dell'home gateway esterno.....	36
Connettori.....	37
DIP Switch	37
Pulsante di configurazione	37
LED.....	38
Installazione dell'antenna ZigBee e del modulo esterno.....	39
Installazione dell'home gateway	42
Linee guida per l'installazione	42
Collegamento dell'Home Gateway.....	43
Verifica della connessione.....	44
Nederlandse.....	45
SolarEdge ZigBee Kit Installatiegids	45
Gebruikerinterfaces Home Gateway	46
Aansluitingen	47
DIP-switches.....	47
Configuratieknop	47
LEDs	48

De ZigBee antenne en Slave-module installeren	49
Home Gateway installatie.....	51
Installatie richtlijnen	51
De Home Gateway aansluiten.....	52
De verbinding controleren	52



English

English

SolarEdge ZigBee Kit Quick Installation Guide

This quick guide describes how to connect a SolarEdge ZigBee home gateway and a ZigBee slave device. One slave device is supplied with this kit. For full installation and safety details refer to the *SolarEdge Home Gateway Installation Guide* and to the *SolarEdge ZigBee Slave Kit Installation Guide*. Make sure you read, fully understand and follow the detailed instructions in them prior to each installation. **Failure to do so may result in damage to the equipment and will void its warranty.**

Home Gateway User Interfaces

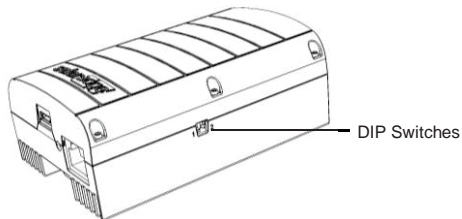
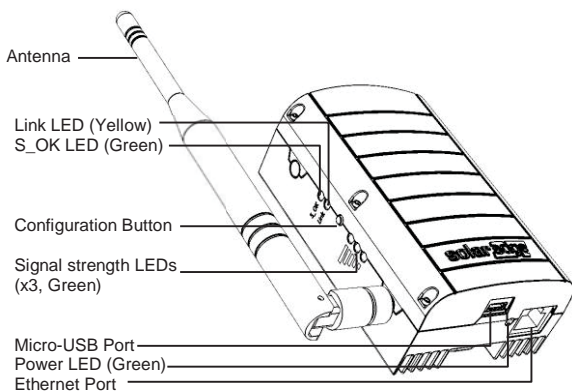

Connectors

- **Micro-USB:** Connection to the power supply. This port can also be used for connecting to a computer for advanced configuration or SW upgrade.
- **Ethernet:** Connecting the SolarEdge gateway to the SolarEdge monitoring portal through an Ethernet switch/router. The Ethernet switch/router should be connected to the Internet.

DIP Switches

Two DIP switches are located at the side of the gateway. They are used for internal configuration; therefore, their position should not be changed.

Configuration Button

The configuration button is used for the following:

- Discovery of slave devices and associating them to the home gateway
- Diagnosis of communication problems

▶ **To use the configuration button:**

- Short press: Pressing the configuration button for 5-10 seconds and releasing it - discover slaves (device discovery)
- Long press: Pressing the configuration button for more than 10 seconds and releasing it - start diagnostics mode

LEDs

The gateway has four LED indicators, as follows:

Label and Color	Indication	Functionality*
Link (yellow)	Communication with associated slave(s)	<p>Blinking - There has been ZigBee communication in the last 15 minutes. The LED blinks according to the number of slaves as follows: for each slave 0.5 second ON and 0.5 second OFF. This is repeated following a 5 sec. pause.</p> <p>OFF - No communication with any slave in the last 15 minutes</p>
S_OK (green)	Connection with the SolarEdge monitoring portal	<p>ON - Connection with SolarEdge monitoring portal is OK</p> <p>OFF - Communication with the SolarEdge monitoring portal failed</p>
3x Signal strength (green)	Received Signal Strength Indication - Low/Medium/High	<p>All 3 LEDs ON - High</p> <p>Two LEDs ON - Medium</p> <p>One LED ON - Low</p>
Power (green)	Power	Power supply connected to the home gateway

* Functionality during normal operation. During device discovery and diagnostic mode, the LEDs indicate different functionality.

Installing the ZigBee Antenna and Slave Module

Install the supplied ZigBee slave module in the slave device (inverters or SMI; the steps herein describe connection to an inverter).

- 1 Connect the ZigBee antenna to the mounting clip and attach the mounting clip to the top of the inverter or to the wall. Make sure the antenna is vertical.
- 2 Route the antenna cable behind the inverter.

Single phase inverter

Three phase inverter

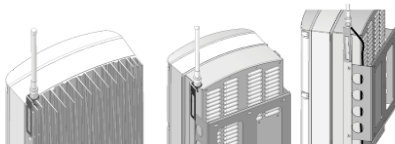

- 3 Disconnect the AC power to the inverter and wait 5 minutes.
- 4 Open the inverter cover as described in its manual.
- 5 Remove the rubber seal from cable gland number 1 and insert the RF cable through the gland and through the gland opening in the inverter.
- 6 Push the cable into the cut opening of the rubber seal.

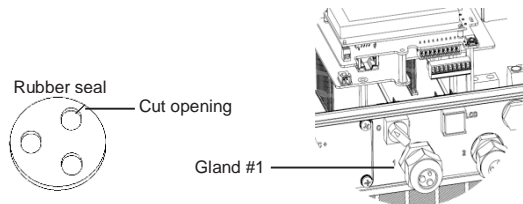

- 7** Insert the rubber seal with the cable into to the gland body and reconnect the gland to the inverter. Tighten the cable gland.
- 8** Connect the ZigBee slave module in its place on the communication board, as shown below.

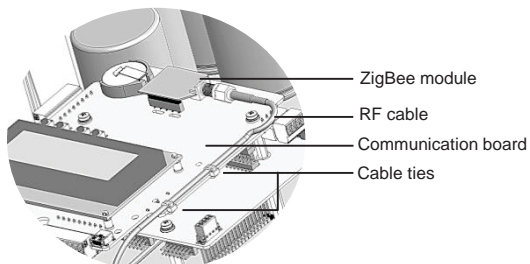

- 9** Route the cable towards the ZigBee module along the communication board side.
- 10** Tighten the cable to the communication board using the two supplied cable ties.
- 11** Connect the RF cable to the ZigBee slave module and tighten manually.
- 12** Close the inverter cover as described in its manual.
- 13** Turn the inverter AC power ON.

The inverter is configured as the slave device by default; therefore, no further configuration is required, unless the default has been changed. In this case, refer to Appendix A of the *ZigBee Slave Installation Guide*.

**NOTE:**

ZigBee is automatically enabled during the discovery of the inverter by the master. Enabling or configuring ZigBee is not required.

Home Gateway Installation

Installation Guidelines

- The SolarEdge home gateway is suitable for mounting indoors only. For outdoor installation, use an external plastic outdoor enclosure (not provided by SolarEdge)
- The SolarEdge home gateway must always remain in an ambient temperature of -20°C (-4°F) to $+60^{\circ}\text{C}$ (140°F).
- Protect the SolarEdge home gateway from dust, wet conditions, corrosive substances, and vapors.
- Install the SolarEdge home gateway on a wall or place it on the desk.
- Ensure that the antenna is vertically oriented.

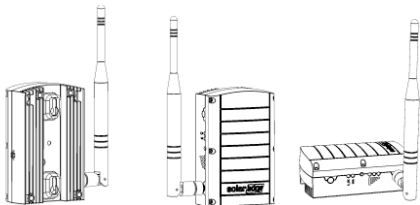

Wall mount option

Connecting the Home Gateway

- 1 Connect the power supply to the Micro-USB connector and connect to an AC source. The power LED is lit to indicate power connection.
- 2 Connect the Ethernet cable between the gateway connector and the router or switch used to connect to the Internet.

- 3 When using a standard automatic DHCP router, there is no need to configure the gateway. If using a static IP instead of automatic DHCP, configure the home gateway as described in Appendix B of the *SolarEdge Home Gateway Installation Guide*.
- 4 **Device Discovery:** Press the configuration button on the home gateway for 5-10 seconds and release it after all LEDs have turned on. The gateway starts discovering the slave device(s). The device discovery may take 2-3 minutes, during which all the LEDs blink. The signal strength LEDs also light up.

Verifying the Connection

- 1 Verify that the S_OK LED is ON, which indicates the communication with the SolarEdge portal is established. This may take up to five minutes. If the LED does not light up, refer to Appendix A in the *SolarEdge Home Gateway Installation Guide*.
- 2 After device discovery, verify that the yellow (Link) LED blinks and indicates the correct amount of slaves, as described in the following illustration. There can be more than two slaves.

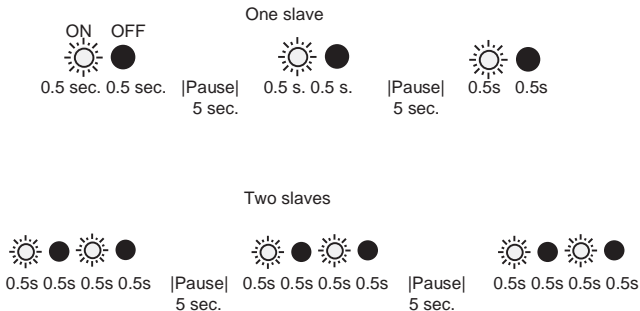

- 3 Verify signal strength: Check that at least two signal strength LEDs are ON, which indicates medium signal strength. If only one LED is ON, the signal strength is Low. Consider relocating the home gateway closer to the inverter to improve reception. If all signal strength LEDs are OFF, consider using a SolarEdge ZigBee repeater (sold separately) between the home gateway and the inverter. Refer also to the troubleshooting in Appendix A of the *SolarEdge Home Gateway Installation Guide*.