



STACK'D SERIES

Install Manual v1.0



© 2023 Lithion Battery Inc. All rights reserved.

The information contained in this manual is protected by copyright and other intellectual property rights owned by Lithion Battery Inc. Any modification, copying, or reproduction of this manual, either in whole or in part, is strictly prohibited without the prior written permission of Lithion Battery Inc.

For the most up-to-date HomeGrid documents, please visit homegridenergy.com.

All mentioned brands and trademarks in this document belong to their respective owners and their use does not imply endorsement or affiliation with their products or services.

To ensure optimal product reliability and eligibility for warranty, please carefully read this document. For more information on the warranty, please refer to the **HomeGrid Limited Warranty**.

This document is intended for use by professional installation and maintenance service providers only and no statements, information or recommendations in this document constitute any express or implied warranty.



Prior to installing or using the HomeGrid equipment, please read this document thoroughly. Failure to follow the instructions or warnings in this document may result in equipment damage, electrical shock, serious injury, or even death.

Product Information

HomeGrid's line of products is constantly evolving. This document specifically pertains to the HomeGrid Stack'd Series. Lithion Battery Inc. ("HomeGrid") reserves the right to make improvements to the product and update the contents of this document without prior notification.

All images and illustrations provided in this manual are for demonstration purposes only and may differ in detail from the actual product, depending on the product version.

User Feedback

If you have any questions or comments, please email us at support@lithionbattery.com

Proper Handling of Discarded Products



Scrapped and discarded products, including their internal chemicals and electrical components, should not be disposed of with household waste. Please consult your local laws and regulations for proper disposal methods.

CONTENTS

SAFETY STATEMENTS	1	SUPPORTED INVERTERS	28
Critical User Information	1	Inverter Brands	28
Safety Symbols	1	Inverter Specific Pin-out Guide	29
 WARRANTY STATEMENT	 2		
 PREPARING TO INSTALL	 3		
Tools	3		
Torque Requirements	4		
Installation Location Requirements	4		
Included Package Contents	6		
Battery Cable Guide	7		
 10 STEP INSTALLATION GUIDE	 8		
1. Unpacking and Identifying Included Hardware	8		
2. Stacking Modules + Removing Side Panels	8		
3. Initial DIP Switch Settings	9		
4. Power On Sequence + Detection Mode	12		
5. Set the “Inverter Set” DIP Switches	16		
6. Cable Installation + Management	16		
7. Optional Install Features	18		
8. Connect the Battery to Wi-Fi (HomeGrid App)	19		
9. Reattach Panels + Ensure Wire Management	26		
10. Calibrating + Balancing the System	26		

SAFETY STATEMENTS

Critical User Information

The HomeGrid Stack'd Series is an electrical device. It is imperative that you thoroughly review this entire document to guarantee the correct utilization of the HomeGrid Stack'd Series system. Neglecting to adhere to these guidelines may render the warranty null and void. It is of utmost importance that you strictly adhere to the safety instructions provided in this manual during operation, as failure to do so may lead to equipment malfunction, electrical shock, severe injury, or even fatality.

Safety Symbols

This Manual contains the following safety symbols, as shown below.



DANGER: This signifies a dangerous situation which, if not avoided, may result in serious injury or death.



WARNING: This signifies a situation where failure to follow instructions may be a hazardous to your safety or lead to equipment malfunction. Follow instructions carefully and use caution.



NOTE: This signifies information useful to ensure optimal system operation. Closely follow these guidelines.



ELECTRONIC DEVICE: DO NOT THROW AWAY!
All scrapped products (including their internal chemicals and electrical materials) should not be disposed of with household wastes. Please refer to your local laws and regulations regarding disposal.

* The DANGER, WARNING, and NOTE alerts serve as additional safety instructions and do not encompass every possible scenario.

WARRANTY STATEMENT

In order to comply with the warranty conditions, it is essential to ensure the correct installation and operation of the HomeGrid Stack'd Series battery system as per the instructions provided in the relevant HomeGrid documents.

To fully secure the 10-year warranty, it is necessary to maintain a reliable internet connection for the HomeGrid Stack'd Series system, enabling access to remote services offered by HomeGrid. In the event of an extended absence or interruption of the internet connection, which hinders HomeGrid's ability to establish contact, the warranty may be limited to a duration shorter than 5 years.

For further details regarding the warranty, please reach out to your regional HomeGrid Representative. They will be able to provide you with comprehensive information and address any queries you may have.

PREPARING TO INSTALL

Tools

- Safety Glasses
- Shock Resistant Gloves
- Closed-toed Shoes (Steel-Toed Recommended)
- Respirator
- Electric Drill/Driver
- Adjustable Wrench
- Torque Wrench
- Linesman Pliers
- Screwdriver Set
- Level
- Digital Multimeter
- Electrical Tape
- Smartphone with the HomeGrid app installed



Special care must be taken to protect personal safety. PPE must be worn during installation, such as insulated gloves, goggles, and safety shoes.



Use properly insulated tools to prevent accidental electric shock or short circuits. If insulated tools are not available, cover the entire exposed metal surfaces of the available tools, except their tips, with electrical tape.

Torque Requirements

Screw Type	Screwdriver	Torsion
M3*12	5mm Phillips	0.55 ± .055 N.m 4.87 in-lb ± 0.49 in-lb
M4*12	5mm Phillips	1.20 ± 0.12 N.m 10.62 in-lb ± 1.06 in-lb
M5*16	5mm Phillips	2.80 ± 0.28 N.m 24.78 in-lb ± 2.48 in-lb
M8*18	M8 Socket	12 ± 1.2 N.m 106.21 in-lb ± 10.62 in-lb

Installation Location Requirements

The HomeGrid Stack'd Series is recommended to be installed indoors or in accordance with local code ordinances for your area (Contact your HomeGrid Rep for additional guidance). If installing outdoors, please ensure you follow the guidelines indicated below to protect the system in accordance with warranty requirements.

- In all cases, the battery should be installed in a sheltered location that is protected from direct exposure to sunshine, rain, or snow for long periods of time. **Do not install in direct sunlight.**
- The proprietary outdoor case will not protect from extreme temperatures. If using the outdoor case, **do not install in direct sunlight.**
- It is essential to ensure that the Stack'd Series installation

area is safeguarded against children and animals accessing it and kept distant from potential sources of heat, fire, water, flammable or explosive materials, dust, smoke uneven surfaces, as well as grassland or soft ground.

- The installation location should drain properly so there is no standing water.
- The floor should be flat, level, and capable of supporting the weight of the system.
- The ambient temperature of the area should be between 0° C to 50° C (32° F to 122° F).
- Keep the exhaust air of the inverter at least 20 inches away from the battery.

There is no ventilation required for the Stack'd Series battery, but due to the heat given off from the battery and inverters, take caution when installation in a small space or closed off area. Avoid areas of high salinity, humidity, or temperature.





Please handle with care. Do not utilize a product that has been dropped, incurred water damage, or been subjected to a significant impact force, as doing so may give rise to potential safety hazards, including cell leakage and the risk of electric shock. Contact HomeGrid immediately if battery is damaged.



If the ambient temperature is outside the operating range the battery pack will stop operating to protect itself. The optimal temperature range for the battery pack to operate is 0°C to 55°C. Frequent exposure to harsh temperatures may reduce the performance and life of the battery pack.

Included Package Contents

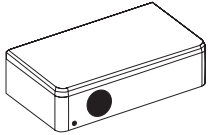
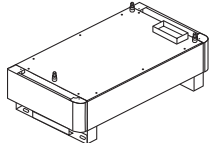
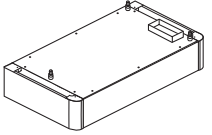
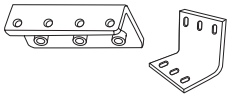
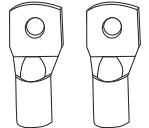
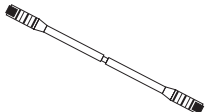
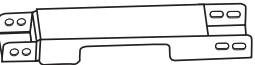
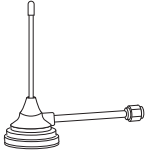
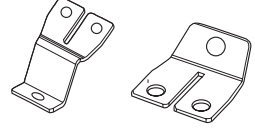
After receiving the system, please ensure that all the following components are not lost or damaged. Contact HomeGrid Support if any components are missing or damaged.

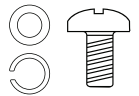
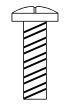
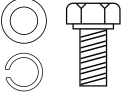
		 4.8 kWh Battery Module
 Controller Fixing Bracket x2	 Battery Terminal Lugs x2	 RJ45 Wire x2
 Grounding/Fixed Frame	 Antenna	 Positive and Negative Terminal Busbars x2
 M3*12 x 3	 M4*12 x 4	 M5*16 x 6
 M8*18 x 2		

Battery Cable Guide

Each system will include positive and negative battery terminal lugs (measuring 3/8 inches, suitable for 4/0 cable). These terminal lugs do not come connected to a cable. Make sure to use the correct cable gauge for the intended system configuration being installed (Use 4/0 cable to anticipate potential system expandability), along with the supplied battery terminal lugs. While the distance limits may vary per installation, anticipate a drop in voltage after 20 feet.

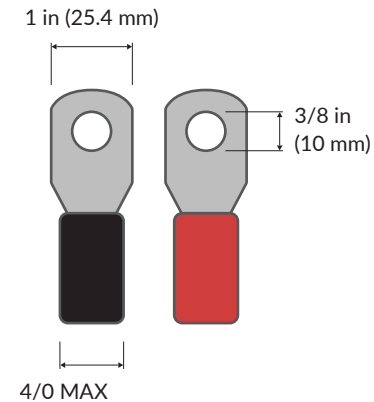

Distance Range:
0'-20' : 4/0

10 STEP INSTALLATION GUIDE

This guide is specifically for a Gen 3 (3rd generation) Stack'd Series system. The easiest way to tell if your system is a Gen 3 is to look for the gold Wi-Fi antenna port on the side of the BMS. All Gen 3 BMS's have a Wi-Fi antenna port.

1. Unpacking and Identifying Included Hardware

- a) Keep the hardware
 - Each BMS ships with a packet of cables and hardware (see above)
 - Each battery module ships with a bag of brackets (see above)
- b) Open the BMS/Base box first. Have the base on the ground before you start unboxing and stacking your battery modules.

2. Stacking Modules + Removing Side Panels

- a) Lift the battery modules with two people (each is 110 lbs.)
- b) Remove the protective black covers off each of the battery modules and stack the first battery module on top of the grey base.
- c) Stack the battery modules on top of each other. As you stack, remove the side panels on each battery module, giving access to the power buttons and DIP switches for future steps. Be careful with the pins of the connection port on each module when stacking.
- d) Stack the grey BMS on top of the battery modules and remove the side panel, giving access to the battery cable terminals, DIP switches, and various ports necessary for installation.

- e) The smallest configuration possible is (2) 4.8 kWh modules, for a total of 9.6 kWh. The maximum configuration within a single stack is (8) 4.8 kWh modules, for a total of 38.4 kWh. (You can parallel up to (15) 38.4 kWh systems, for a total of 576 kWh's)

3. Initial DIP Switch Settings

The BMS and battery modules use DIP switches to operate and perform several functions- without certain DIP switch settings, the system will not operate as intended. These DIP switches are utilized to identify and orient each module in the stack, facilitate communication between components, connect to Wi-Fi, check installed firmware, and connect to specific inverters.

Please make sure when setting each DIP switch, that the DIP switch is completely pushed to the up or down position. Power cycling the BMS is required whenever the DIP switch settings are changed when the BMS is **ON**. This is to ensure that the BMS is operating in the intended mode configured for, as indicated by the position of the DIP switches.

Incorrect DIP switch settings in general can cause:

- Error codes
- Incorrect number of batteries icons blinking on BMS display screen
- Modules not powering on

The DIP switches on the BMS have many functions, including:

- Enabling 'Hardware Detection Mode' for detecting # of battery modules installed.
- Enabling 'Firmware Detection Mode' for checking currently installed firmware on the stack (BMS, Battery Modules)
- Enabling 'Wi-Fi Connection Mode' to allow completing setup for remote monitoring via the HomeGrid App

(Code 56).

- Enabling 'Connection Status Mode' for checking the 'online status' (Code 60).
- Enabling 'Parallel Detection Mode' for systems being configured in parallel (Stacks 2-15).

The DIP switches on the battery modules function to:

- Identify and orient the module according to its position in the stack.

Set the Module Address Set DIP Switches

The DIP switch settings on the battery modules should be set according to their position in a stack. For ease of simplicity, we recommend that you address the first module beneath the BMS as battery module #1 and continue downward in this format until the last module for your given configuration. See chart for recommended numbering sequence and the associated DIP switch settings for each module.

The DIP switches on the modules should be set depending on how many battery modules are within the stack. Ensure that the battery modules and BMS are not powered on as you are making these DIP switch changes. Once you have set the DIP switches to the correct position for every battery module (see Address Settings diagram on page 11) and set the correct DIP switches on the BMS's address set (all down, except 1-- see Detection Mode diagram on page 11), you can move to step (4).

At this point, all power buttons should be pressed **OFF**.

Detection Mode

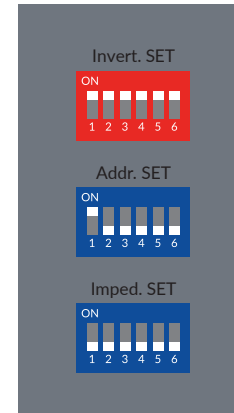

Address Settings

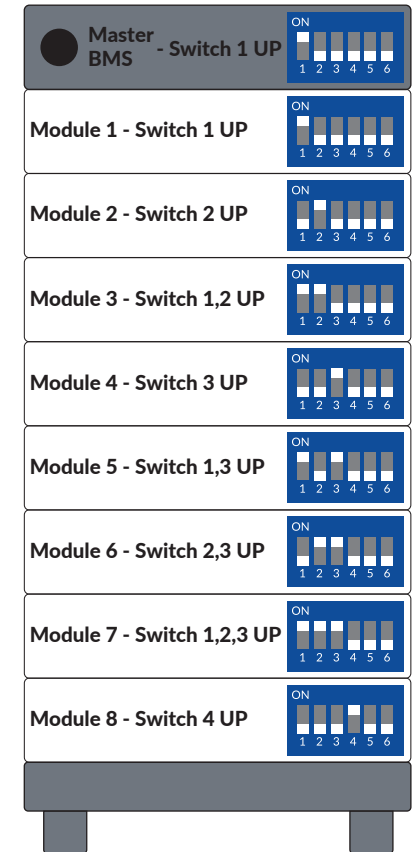

4. Power On Sequence + Detection Mode

Now, for the BMS of the system, we need to run a detection of how many battery modules have been stacked. Follow the order of operations below in careful detail.

- On the BMS, flip the red “invert set” DIP switches *all* UP, #1-6 (this puts the BMS in detection mode).
- Power **ON** the battery modules, **starting from the bottom battery module to the top.** (After you power **ON**, a green light should appear)
- Power **ON** the BMS. The BMS display will show various information as the system boots.
- After what can take up to 3 minutes, the BMS display will flash the number of battery modules it detected within the stack (2-8). Wait 30 seconds after all modules are detected before proceeding to the next step.

If this number is not correct, check that you’ve powered on all modules, and set their DIP switches correctly. Additionally, check that the DIP switch settings on the BMS are correct.

4a. PARALLEL ONLY: Setting the “Address Set” DIP Switches

This step only applies to installs utilizing multiple Stack’d Series batteries running in parallel. As mentioned in the last step, the DIP switches on the modules should be set depending on how many battery modules are within the stack. Those setting do not change for the battery modules. Note however, that the **address set** DIP switches on the master battery stack are set to #1 UP, with the rest DOWN (#2-6), while the second battery in parallel’s address set is according to its position in parallel (#2 is UP, while #1 and #3-6 are DOWN).

If you are installing more than two stacks in parallel, use the chart on page 15 for the address set DIP switches. At this point, all power buttons should be pressed **OFF**.

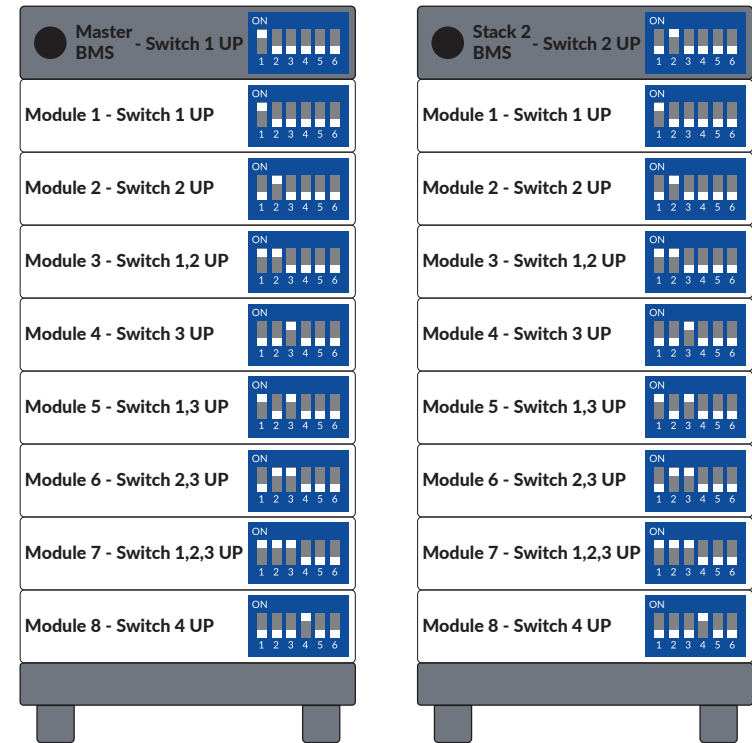

	Addr. SET DIP Switch Positions					
	1	2	3	4	5	6
Master BMS	ON	OFF	OFF	OFF	OFF	OFF
Stack 2 BMS	OFF	ON	OFF	OFF	OFF	OFF
Stack 3 BMS	ON	ON	OFF	OFF	OFF	OFF
Stack 4 BMS	OFF	OFF	ON	OFF	OFF	OFF
Stack 5 BMS	ON	OFF	ON	OFF	OFF	OFF
Stack 6 BMS	OFF	ON	ON	OFF	OFF	OFF
Stack 7 BMS	ON	ON	ON	OFF	OFF	OFF
Stack 8 BMS	OFF	OFF	OFF	ON	OFF	OFF
Stack 9 BMS	ON	OFF	OFF	ON	OFF	OFF
Stack 10 BMS	OFF	ON	OFF	ON	OFF	OFF

4b. PARALLEL ONLY: Linking Parallel Stacks with Communication Cables

This step only applies to installs utilizing multiple Stack'd Series batteries running in parallel. At this point, all power buttons should be pressed **OFF**.

- Use a standard Ethernet cable to connect the stacks. There is an extra Ethernet cable included in the packaging for this purpose.
- Connect the cable to the "Link A" port of the master BMS
- Connect the other end of the cable to "Link B" port of the paralleled BMS
- For installs with more systems in parallel, repeat the pattern of Link A to Link B

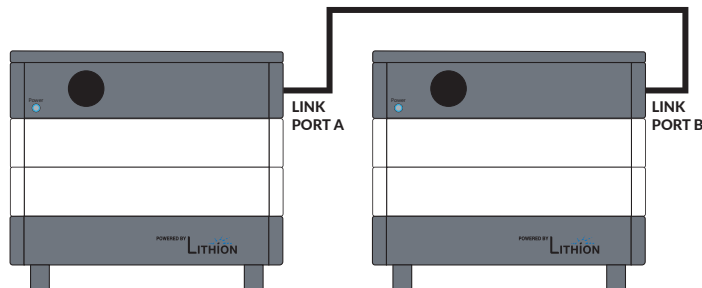

4c. PARALLEL ONLY: Parallel Detection Mode

This step only applies to installs utilizing multiple Stack'd Series batteries running in parallel. After completing step 4 for each battery stack and detecting the number of battery modules, it is now time for the master BMS to detect the number of *paralleled systems* running together. Follow the order of operations below in careful detail. At this point, all power buttons should be pressed **ON** and step 4 should be completed for each individual stack.

- On all batteries running in parallel (except for the master battery), set the red invert set DIP switches to #1 UP, with DIP switches #2-6 DOWN.
- On the master battery, set the red invert set DIP switches to #1 DOWN, with DIP switches #2-6 UP.
- Turn the power button of the BMS **ON**, starting with the *furthest* paralleled system from the master battery. Wait 5 seconds. Then turn the *next* system in parallel BMS **ON** and wait 30 seconds. Repeat and *finish* by turning **ON** the *master* battery's BMS last.
- After what can take up to 3 minutes, the BMS display of the master battery will flash the total number of paralleled systems detected.

If this number is not correct, check that you've powered on all modules and set their DIP switches correctly. Additionally, check that the DIP switch settings on all BMS's in parallel are correct. Check that communications cables are correctly inserted between Link A to Link B.

5. Set the “Inverter Set” DIP Switches

After all the battery modules have been successfully recognized using the “detection” mode (steps 4 and 4A), change the DIP switches on the red “Invert set” on the side of the BMS to match your paired inverter.

Inverter Brand	DIP Switch Position (Invert. SET)					
	1	2	3	4	5	6
Open-Loop	ON	OFF	OFF	OFF	OFF	OFF
Sol-Ark	ON	OFF	ON	ON	OFF	OFF
Schneider XW Pro	OFF	OFF	ON	ON	OFF	OFF
SMA Sunny Island	ON	ON	ON	OFF	OFF	OFF
LuxPower	ON	OFF	ON	ON	OFF	OFF

6. Cable Installation + Management

Battery cables may be installed before or after steps 3-5. In all cases, ensure that the battery modules and BMS are **all powered OFF**. Bus bars, lugs, bolts, and nuts are included in each BMS box. You must use the provided hardware.

Battery Cable Attachment

- Remove the clear plastic covering from over the positive and negative terminals.
- Remove all screws (M8 * 16) from each terminal.
- Attach the included shorter bus bar on the positive terminals and reattach the screws (M8 * 16) securing it into place on the BMS.
- Attach the included longer bus bar on the negative terminals and reattach the screws (M8 * 16) securing it into place on the BMS.

- Attach the included lugs onto the ends of both positive and negative 4/0 battery cables (not included) and slide through the large compression seals. It may be easier to slide the battery cables through the compression seals first and then attach the battery lugs to the battery cables.
- Fasten the M8 bolts connecting the battery cable lugs to the battery terminal busbars using a torque wrench set to 12 ± 1.2 N.m (106.21 in-lb ± 10.62 in-lb).
- Reattach the clear plastic covering over the positive and negative terminals.
- Screw caps back on the compression seals.

Inverter Communication Cable Attachment

- Run the end of the communication cable labeled “BATTERY” through the smaller compression seal on the BMS (Master BMS in a parallel install)
- Plug the communication cable into the INV-CAN port on the battery.
- The other end of the communication cable is labeled “INVERTER” and connects to the CAN port of the inverter.



The cable provided has had its pins specifically adjusted for a Sol-Ark inverter. If you need to make your own cable, you must alter the pin settings on the inverter end. Please see pg. 29 for wiring configurations for other compatible inverter COM cables.

Wi-Fi Cable and Antenna Attachment

- a) Using the smaller compression seal entrance (same as the communication cable), run the Wi-Fi cable through the compression seal, and screw on to the Wi-Fi port.
- b) Place the antenna on top of the Stack'd Series battery.

7. Optional Install Features

Optional: Using expansion bolts, the base stand of the Stack'd Series battery may be bolted to the ground for even further stability.

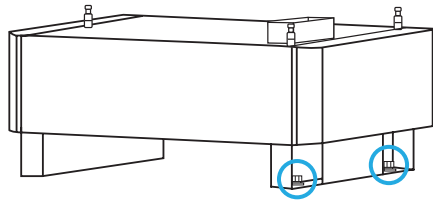

Optional: Using the included wall brackets, the back of the BMS may be fastened to the wall behind it for even further stability.

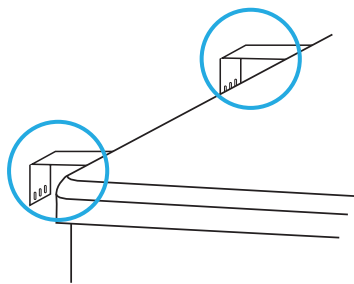

Optional: Using the included battery module fixing brackets (included in each battery module box) the battery modules within the stack can be fastened together for even greater stability. You will need to remove the other side panel on each battery module to access these attachment points. You will also need to remove the top panel of the BMS and the other side panel of the BMS to gain access to the top attachment point. (Doing so will not void the warranty)

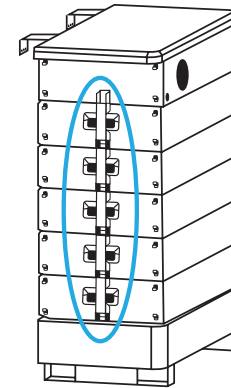

8. Connect the Battery to Wi-Fi via the HomeGrid App

The HomeGrid app is designed for both installers and end users. Depending on the type of user, there are different features within the app. After commissioning the system using steps 1-7, follow these steps to connect it to Wi-Fi.

a. Download the HomeGrid App

The HomeGrid App is available on App Store (iOS) and Google Play Store (Android).

To get a system online (i.e., Skybox, Gen 3 BMS) installers will need to make note of the serial numbers for all devices connected to a stack. Contact HomeGrid Support to link those devices to the installer account.

If the end user does not have access to reliable access to a data connection (mobile/Wi-Fi) on-site, the setup process could be delayed. Also, a steady reliable data connection is required on-site if the battery system is to be monitored remotely. Remote updates are not possible without a steady data connection.



The Stack'd Series battery can only connect to a 2.4Ghz Wi-Fi router, not 5Ghz.

b. Create Account(s)

All installers need to create a HomeGrid account within the app. Before installers even arrive on-site, it's best to contact HomeGrid Support for installer QR codes or assistance in creating an account.

If installers want HomeGrid to create an account on their behalf, they must indicate if they are a company with multiple sub-contractors or an independent installer and provide the following information to the support representative: **Username** (max length of 23 characters), **Email** (max length of 32 characters), **Address** (max length of 64 characters).

Once an account is created, the default password will be '123456789'. We strongly recommend that this password is changed at the installer's earliest convenience (found in Account Settings).



Only letters, numbers, and the underscore '_' character are allowed for a username and password. No spaces are allowed. The username is case-sensitive. We recommend you use CamelCase naming conventions such as 'YourSolarCompany' or 'YourSolarCompany_Installer1'. It is not required but may make profile management easier if there are multiple users.

c. Create Sub-Account(s)

'Installation Company' accounts can create 'Installer' sub-accounts (via QR Code located in Account Settings on the app). Your QR Code will say 'Installation Company'. Provide this QR code to individual installers within your organization if you intend to have multiple users. **Do not provide this QR code directly to homeowners/clients-** this QR code is valid only for creating 'Installer' level accounts. You must create an 'Installer' level account first, then provide the QR Code generated in that account (QR Code will indicate 'Installer') to your homeowner/'End User' clients.



As of this writing, 'End User' (homeowner/clients) app users do not have the same functionality as 'Installation Company' or 'Installer' level accounts, such as the ability to push firmware updates remotely or device parameter changes. This is to prevent system malfunction caused by user error. Contact HomeGrid Support to inquire if an update is available or recommended (online devices only).

d. Device/Account Link with HomeGrid Support

Once the account(s) have been created by the installer, they should contact HomeGrid Support and provide all serial numbers for SkyBoxes (For Gen 2 BMS) or Gen 3 controllers (BMS with Wi-Fi port on the unit) for each Stack'd Series battery they intend to set up for online monitoring. HomeGrid Support will link these devices to their account. If the batteries' serial number is not available for account linking, the installer should allow time for the device to become available and linked to their account. Once available, they can link those devices to lower-level users such as 'Installer' or 'End User' (homeowner/client) accounts.

Installers can still proceed with the Wi-Fi setup (found in Account, select Network option). This step is highly recommended to avoid subsequent visits regarding online

monitoring/app setup. Once the device becomes available to be linked, the installer should see these devices become available online on their account.



If installers forget to set up Wi-Fi on-site, or no local Wi-Fi was available at the time of installation, the installers client may contact HomeGrid Support for setup assistance. Installers must provide their client with the QR code (via email or text) if they wish to monitor that system. Installers should provide a QR code that says 'Installer' or create one within their 'Installation Company' account.

Once HomeGrid has linked to a device (Skybox/Gen 3 BMS), 'Installation Company' accounts can then link specifically to individual 'Installer' accounts. 'Installation Company' accounts can monitor any device linked to their account; however, 'Installer' level accounts can only monitor devices linked specifically to them.

For independent installers, they can link devices to their clients ('End User' accounts) once they've created their accounts using your QR code for authorization.

e. How to Setup Wi-Fi

Hardware/Firmware Requirements for Gen 2 Systems

Installers will need a Skybox interface (Model HG-SB01/Product # 4000040) if connecting to a Gen 2 BMS controller. Installers should contact their distributor to acquire a Skybox, or HomeGrid Support if the distributor is unable to provide one.

- a) Ensure Skybox is connected properly to the controller.
- b) The cable with the end labeled 'CBOX RS232' connects to the 'RS232' port of the Skybox Interface.
- c) The opposite end of the cable labeled 'MATE Master RS232' connects to the 'DBG RS232' port of the BMS Controller. The cable with the end labeled 'CBOX

CAN\RS485' connects to the 'CAN\RS485' port of the Skybox interface.

- d) The opposite end of the cable labeled 'MATE Master-COM' connects to the 'DBG COM' port on the BMS Controller.

Hardware/Firmware Requirements for Gen 3 Systems

Installers must make sure the installed device has the latest firmware, which is displayed on the BMS display screen (v1051), in order to see incoming data from the system. Older firmware will require a Skybox interface (Model HG-SB01/Product # 4000040) to update.

To check your system's firmware installed, follow the procedure below.

- a) Set the 'INVERT SET' DIP switches temporarily to (#2 DOWN #1,3,4,5,6 UP) and wait for firmware versions (VER S.) to appear on the controller; once identified, change the 'INVERT SET' back to their previous settings.
- b) The display must indicate software is updated to version 1.051.

Network Requirements

Use a 2.4 GHz or dual band network router (2.4GHz and 5GHz) is required. HomeGrid devices cannot connect to 5GHz band network routers. Installers must obtain the local Wi-Fi network name and password:

For iOS users, they will be required to enter the SSID (Wi-Fi Network Name) manually. This entry is case-sensitive and must be entered exactly as it's named. We recommend you screenshot the network name and password, then copy and paste from the image.

Set Up Wi-Fi Through the App

Once installers have met all the requirements, they must follow the setup prompts provided upon selecting the 'Network' option within the HomeGrid App. They will be given visual cues for the process and will be redirected to their monitoring device's Wi-Fi settings. You will need to first link to the local hotspot created by the Skybox or Gen 3 BMS. The name of this hotspot will look like the serial number for the device

(Skybox or BMS). Installers then connect to the hotspot and enter 12345678 for its password. Confirm your monitoring device has connected to the hotspot and then return to the app. You should be able to resume from where you last left off, if necessary, press the back button and reengage the setup process.

- iOS users, enter SSID (local Wi-Fi Network name) exactly as detected, along with the password. If successful, you will get a 'Command sent succeeded' message.
- Android users, select the local Wi-Fi Network and enter the password. If successful, you will get a 'Command sent succeeded' message.

Once installers have completed entering the Wi-Fi Network parameters, they should close the HomeGrid Energy app, reconnect to the local Wi-Fi network or mobile data network and reopen the app. Upon opening the app, they may need to refresh the app by pulling down on the home screen with your finger to refresh the app. You will notice at the top, the date and time the app was last refreshed.

Users may be required to refresh the app every time they close and open the app. The app does not automatically refresh. For updated information, refresh as needed.

Confirming Network Connectivity

Once installers have completed setting up network parameters, they can verify that the system is connected to the local Wi-Fi network and is communicating with HomeGrid servers by observing the following:

On **Gen 2** systems using a Skybox interface, notice a green light indicator.

- A steady green indicator means it is connected to the local Wi-Fi network.
- A blinking green indicator means it is connected to the HomeGrid server.

On **Gen 3** Systems, temporarily change 'Invert Set' DIP switches on the BMS to the following:

- (#1,2 DOWN, #3,4,5,6 UP)
- Observe the display on BMS for a code 60 followed by either a 0, 1, or 2
 - 0 Indicates no connection to Wi-Fi.
 - 1 indicates a connection to local Wi-Fi.
 - 2 indicates a connection to Wi-Fi and HomeGrid server.
- Return the 'Invert Set' DIP switches to their previous settings.

Please contact HomeGrid Support at [725-373-5350](tel:725-373-5350) or email support@lithionbattery.com for assistance.

9. Reattach Panels + Ensure Proper Wire Management

With all the battery modules turned **ON** and detected, and the BMS turned **ON**, your Stack'd Series battery system is functioning properly for use with an inverter.

- a) Reattach all side panels for each battery module.
- b) Reattach all side panels on the BMS (will need to access BMS DIP switches in step 10).
- c) Ensure all battery cables are safely managed and protected.

10. Calibrating + Balancing the System



This step is absolutely critical to the health of your battery.

For the initial balancing of the battery modules, it is required that you cycle the system after installation. It is recommended to cycle 2-3 times after installation, within the first week on site. A complete cycle would be a discharge down to 20% SOC (State of Charge), and then a complete recharge to 100% SOC. If the battery icons on your Stack'd Series battery are still flashing after 3 cycles, please contact HomeGrid Support.

Since the SOC of each battery module could be different for different reasons and may require some time to 'balance out'. If the battery modules were detected by the BMS in the 'hardware detection mode' procedure earlier, then the battery modules should just need charging or even discharging for a while to get the system to balance out.

- A slow flashing of the battery icons (about a second) means the battery modules need to 'balance out' through charging or discharging.
- A fast-blinking battery icon on the BMS (less than a second) most likely means some sort of internal

communication issue, even if the battery modules were detected. This most likely can be fixed with a firmware update. If the system firmware, specifically the EMS (display) is not too old (v1051 or newer), then HomeGrid Support or the installer (whenever that feature is available to them) could push a remote update to the system if it's been configured with the local Wi-Fi on-site.

- If the system cannot be updated on-site through a remote update, then the installer will need an external Skybox and the latest firmware to be able to eliminate any issues that could potentially come up if not updated.
- If the installer is new to installing HomeGrid Battery systems, doesn't have a Skybox and the firmware on the system is too old, then we'll need to send them out a Skybox to fix any potential issues. We've been telling them to hold on to the SkyBoxes in the likely event they encounter another battery system that needs to be updated.

SUPPORTED INVERTERS

Inverter Brands

The HomeGrid Stack'd Series battery system requires an inverter to transition between DC power from the batteries and AC current for utilities such as lighting, appliances, and HVAC systems. Additionally, the inverter facilitates the DC power supply for battery recharging. The Stack'd Series BMS communicates with smart inverters, exchanging data on voltages, currents, and other parameters.

Currently, the Stack'd Series is compatible with smart inverters from multiple manufacturers. Installers should ensure the BMS is connected to the inverter using the appropriate cable configuration and set the BMS to the corresponding inverter protocol, as detailed in Step 5.

For future inverter compatibility updates, refer to our official website.



HomeGrid's Stack'd Series systems are pre-configured to operate with smart inverters from multiple manufacturers in closed-loop mode. Simply connect the appropriately configured communication cable between the BMS and inverter as detailed in Step 5.

While we strive to keep our compatibility list updated, the

inverters listed may not always reflect the most recent versions. Software upgrades can alter this list, and our reference manual might not be immediately updated to match these changes. For the latest information on supported inverters, please refer to our official website or contact our support team.

It's essential to note that firmware updates for equipment, such as inverters connected to HomeGrid's battery systems, can sometimes lead to communication or performance issues. Always ensure that the firmware of all interconnected devices is compatible before initiating updates. For further clarity, reach out to the respective equipment manufacturers or HomeGrid Support.

If an inverter manufacturer updates its software, it might disrupt the communication between our battery and the inverter. Before interfacing with a specific inverter, verify that its software version aligns with our compatibility list. If there's a discrepancy, please get in touch with us.

Inverter Specific Pin-out Guide

Manufacturers may upgrade their products resulting in hardware communication interface changes. If communication is not possible in the application according to the following wiring method (see below), please contact us.

The CAN/RS485 communication port of HomeGrid is connected to the communications interface of the inverter. The pins within the communications cable need to be set as shown on page 30.



The CAN cable included is pre-wired for a Sol-Ark, SMA, and Goodwe inverter.

If re-wiring the cable, please use the Brown and Brown/White wires accordingly:

CAN_H - Brown

CAN_L - Brown/White

Example:

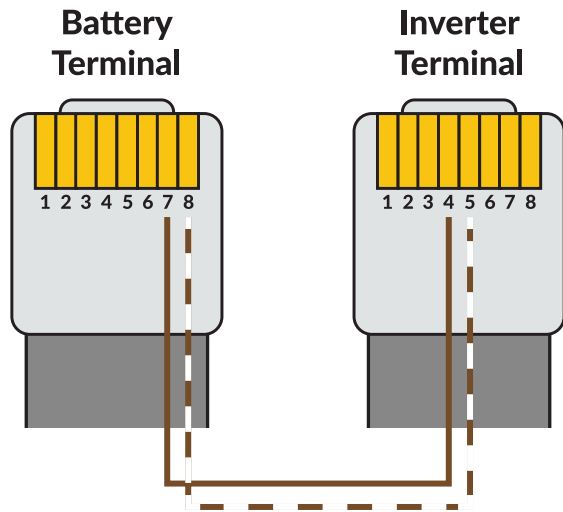

Pin-out Guide

Sol-Ark				LuxPower			
Battery		Inverter		Battery		Inverter	
CAN_H	CAN_L	CAN_H	CAN_L	CAN_H	CAN_L	CAN_H	CAN_L
7	8	4	5	7	8	4	5
Growatt				Victron			
Battery		Inverter		Battery		Inverter	
CAN_H	CAN_L	CAN_H	CAN_L	CAN_H	CAN_L	CAN_H	CAN_L
1	2	1	2	7	8	7	8
SMA				Goodwe			
Battery		Inverter		Battery		Inverter	
CAN_H	CAN_L	CAN_H	CAN_L	CAN_H	CAN_L	CAN_H	CAN_L
7	8	4	5	7	8	4	5
Schneider (Gateway)				Schneider (Insight Home)			
Battery		Inverter		Battery		Inverter	
CAN_H	CAN_L	CAN_H	CAN_L	CAN_H	CAN_L	CAN_H	CAN_L
7	8	14	12	7	8	12	10



STACK'D SERIES

User Manual v1.0



© 2023 Lithion Battery Inc. All rights reserved.

The information contained in this manual is protected by copyright and other intellectual property rights owned by Lithion Battery Inc. Any modification, copying, or reproduction of this manual, either in whole or in part, is strictly prohibited without the prior written permission of Lithion Battery Inc.

For the most up-to-date HomeGrid documents, please visit homegridenergy.com.

All mentioned brands and trademarks in this document belong to their respective owners and their use does not imply endorsement or affiliation with their products or services.

To ensure optimal product reliability and eligibility for warranty, please carefully read this document. For more information on the warranty, please refer to the **HomeGrid Limited Warranty**.

This document is intended for use by professional installation and maintenance service providers only and no statements, information or recommendations in this document constitute any express or implied warranty.



Prior to installing or using the HomeGrid equipment, please read this document thoroughly. Failure to follow the instructions or warnings in this document may result in equipment damage, electrical shock, serious injury, or even death.

Product Information

HomeGrid's line of products is constantly evolving. This document specifically pertains to the HomeGrid Stack'd Series. Lithion Battery Inc. ("HomeGrid") reserves the right to make improvements to the product and update the contents of this document without prior notification.

All images and illustrations provided in this manual are for demonstration purposes only and may differ in detail from the actual product, depending on the product version.

User Feedback

If you have any questions or comments, please email us at support@lithionbattery.com

Proper Handling of Discarded Products



Scrapped and discarded products, including their internal chemicals and electrical components, should not be disposed of with household waste. Please consult your local laws and regulations for proper disposal methods.

CONTENTS

- SAFETY STATEMENTS 1**
 - Critical User Information1
 - Safety Symbols1
 - Safety Instructions- Warning & Danger Statements2
- WARRANTY STATEMENT 7**
- SERVICE & MAINTENANCE 8**
 - Service8
 - Maintenance9
- SYSTEM OVERVIEW 10**
- SYSTEM COMPONENTS 10**
 - Stack'd Series BMS - Display10
 - Stack'd Series BMS - Error Codes Reference Chart12
 - Stack'd Series BMS - DIP Switches and Connectors ...13
 - Stack'd Series 4.8 kWh Battery Module14
 - Stack'd Series Base Stand15
- ACTIVATION + SHUT OFF 16**
 - Starting Up The System16
 - Shutting Down The System16
 - Emergency Response16

- BACKUP OPTIONS18**
 - Whole Home Backup (Line Side Tap) 18
 - Whole Home Backup (Load Side Tap) 19
 - Partial Home Backup 20
- THE HOMEGRID ENERGY APP21**
- TROUBLESHOOTING22**
 - Common Questions + Solutions 22
 - Technical Support 24

SAFETY STATEMENTS

Critical User Information

The HomeGrid Stack'd Series is an electrical device. It is imperative that you thoroughly review this entire document to guarantee the correct utilization of the HomeGrid Stack'd Series system. Neglecting to adhere to these guidelines may render the warranty null and void. It is of utmost importance that you strictly adhere to the safety instructions provided in this manual during operation, as failure to do so may lead to equipment malfunction, electrical shock, severe injury, or even fatality.

Safety Symbols

This Manual contains the following safety symbols, as shown below.



DANGER: This indicates a hazardous situation which if not avoided, may result in death or serious injury.



WARNING: This indicates a situation where failure to follow instructions may be a safety hazard or cause equipment malfunction. Use extreme caution and follow instructions carefully.



NOTE: This indicates information that is important for optimal system operation. Closely follow instructions.



ELECTRONIC DEVICE: DO NOT THROW AWAY!

All scrapped products (including their internal chemicals and electrical materials) should not be disposed of with household wastes.

Please refer to your local laws and regulations regarding disposal.

* The DANGER, WARNING, and NOTE alerts are supplemental to the safety instructions and are not exhaustive.

Safety Instructions- Warning & Danger Statements



The HomeGrid Stack'd Series consists of electrical equipment that, if not used correctly, can pose risks such as electrical shock and fire hazards. It is essential to note that any misuse of the equipment may result in the warranty becoming void. Only electricians who are certified and qualified by HomeGrid should be entrusted with the installation, maintenance, or replacement of HomeGrid's equipment or wiring. It is imperative for them to wear appropriate personal protective equipment (PPE) while performing any operations.



To prevent any inadvertent operational errors, it is essential to disconnect and securely padlock the upstream and downstream switches during the installation or maintenance process.



In the event that the HomeGrid Stack'd Series exhibits signs such as electrolyte leakage, smoking, or fire, and it is deemed unsafe to proceed, take immediate action to disconnect the DC power from the system. Additionally, ensure to turn off the Battery Management System (BMS) and power down all modules to halt the charging and discharging processes of the battery system. This precautionary measure aims to mitigate any potential risks and safeguard against further damage.



As some components of the Stack'd Series weight about 110 lbs, it is highly recommended that 2 people install the system together. Having an assistant present serves as a precautionary measure to mitigate risks and address any unforeseen circumstances effectively.



Maintain a safe distance from any materials that are flammable or explosive.



Implement protective measures to prevent access by children.



During the installation and maintenance of the HomeGrid Stack'd Series, it is crucial to prevent the insertion of foreign objects between battery modules.



Throughout the utilization, storage, and transportation of the HomeGrid Stack'd Series, it is crucial to maintain the ambient temperature below 140°F (60°C). This precautionary measure guarantees the optimal performance and longevity of the equipment while mitigating any potential risks associated with excessive heat.



Exclusively utilize parts or accessories that have been procured from HomeGrid or a certified HomeGrid supplier. This ensures compatibility, reliability, and compliance with necessary standards.



Refrain from activating the modules before connecting the system to the PV and grid. Failure to follow this guideline may lead to battery depletion due to an extended period without charging. If the system is to be dormant, the whole system should be turned completely **OFF** for that period of time.



For the HomeGrid Stack'd Series battery to update properly, an internet connection is necessary. To obtain detailed information and guidance, please reach out to HomeGrid's Support team, who will provide the necessary support and address any queries you may have.



Under no circumstances should HomeGrid equipment be installed, maintained, or handled outdoors during inclement weather conditions, including thunderstorms, rainfall, snowfall, and high winds.



During the transportation and handling of HomeGrid equipment, exercise extreme caution and take all necessary measures to prevent dropping, bumping, stomping, or inverting the equipment.



To safeguard against potential damage, it is recommended to keep the HomeGrid Stack'd Series BMS/Base and battery modules within their designated shipping packaging until all the necessary equipment is prepared for installation.



Under normal circumstances, refrain from painting any component of the HomeGrid Stack'd Series unless the paint surface of the equipment housing has incurred accidental damage during transportation, installation, or maintenance. In the event of such damage, the affected area can be appropriately restored using paint or a topcoat that matches the original color, ensuring a seamless appearance and maintaining the equipment's aesthetic integrity.



When installing the HomeGrid Stack'd Series, position it at a safe distance from heating equipment or any potential sources of heat and fire.



For optimal performance, it is recommended to install the HomeGrid Stack'd Series in a well-ventilated area that is dry and cool.



When installing the HomeGrid Stack'd Series, it is important to select a location that is not directly exposed to sunlight, rain, or snow. By avoiding direct exposure to these elements, you can prevent potential adverse effects such as heat buildup, water damage, or moisture infiltration, ensuring the optimal performance and durability of the equipment. Failure to do so may void the warranty.



If the equipment is situated in proximity to a garage or parking area, it is crucial to provide adequate protection to prevent collision and impact-related damages from vehicles.



During installation, position the HomeGrid Stack'd Series away from standing water or areas prone to water pooling. Keep away from water sources including faucets, downspouts, or sprinklers.



In the event of any equipment failure, promptly reach out to your installer or authorized after-sales service provider for assistance and support. Refrain from attempting to dismantle, repair, or modify the HomeGrid Stack'd Series without obtaining proper authorization from HomeGrid. Unauthorized actions of this nature may pose safety risks and also result in the voiding of your warranty.



When installing the HomeGrid Stack'd Series on the floor, ensure that the chosen location is level, solid, and not susceptible to sink. It is often necessary to place a layer of cement board or slab stone on the equipment's projected area to maintain stability, thereby avoiding any potential collapse.



If any functional or cosmetic damage to the HomeGrid Stack'd Series is observed upon unboxing (excluding minor paint damage), promptly contact HomeGrid's support team for necessary support and assistance.



During the installation, wiring, maintenance, transportation, and handling processes of the HomeGrid Stack'd Series battery, adhere to local laws, regulations, and standards. The safety instructions provided in this guide should be seen as supplementary guidelines to complement and enhance compliance with these legal requirements.

WARRANTY STATEMENT

In order to comply with the warranty conditions, it is essential to ensure the correct installation and operation of the HomeGrid Stack'd Series battery system as per the instructions provided in the relevant HomeGrid documents.

To fully secure the 10-year warranty, it is necessary to maintain a reliable internet connection for the HomeGrid Stack'd Series system, enabling access to remote services offered by HomeGrid. In the event of an extended absence or interruption of the internet connection, which hinders HomeGrid's ability to establish contact, the warranty may be limited to a duration shorter than 5 years.

For further details regarding the warranty, please reach out to your regional HomeGrid Representative. They will be able to provide you with comprehensive information and address any queries you may have.

SERVICE & MAINTENANCE

Service

- Place the equipment away from hazardous zones and potential risks.
- Maintain suitable temperature and humidity levels (as outlined in the Stack'd Series Specification Sheet located on our website at 'Resources > Specification Sheets > Stack'd Series') in the environment where all HomeGrid equipment is located.
- Ensure the HomeGrid Stack'd Series is positioned away from direct sunlight.
- Ensure all cables are securely wired and connectors are free from stress.
- Avoid allowing any leaves or foreign objects near the HomeGrid Stack'd Series, particularly ensuring there is no accumulation of debris on top or between the unit and the back wall.
- Operate the equipment within the allowed power range and avoid overloading.
- Keep all pieces of the equipment at a safe distance from flammable, explosive, and/or poisonous materials.
- It is recommended to have a smoke detector nearby if the equipment is installed indoors.
- Clean the surface of the equipment using a soft cloth. If necessary, slightly dampen the cloth with water only and ensure the equipment is fully de-energized.

Maintenance

- Regularly verify that information on the LCD display of the Stack'd Series BMS aligns with the information displayed on the app.
- Refrain from attempting to repair the system independently. Instead, seek assistance from professionals authorized by HomeGrid.
- Use your mobile app to monitor the operational status of your equipment. If you encounter any alarms or alerts, consult the Error Codes Reference Chart on page 12. Promptly reach out to HomeGrid Support for assistance.

SYSTEM OVERVIEW

The HomeGrid Stack'd Series battery system is a modular energy storage system designed for residential and commercial users. The key components are the BMS (Battery Management System), which operates as the top module in the stack and has several functionalities, the base stand, and the 4.8 kWh LFP battery modules built to store energy. Multiple battery modules (2-8) can be vertically connected in parallel to expand capacity and power in order to meet the requirements of the system. Users can monitor and operate their HomeGrid Stack'd Series systems remotely via the HomeGrid Energy mobile phone app.

SYSTEM COMPONENTS

Stack'd Series BMS - Display

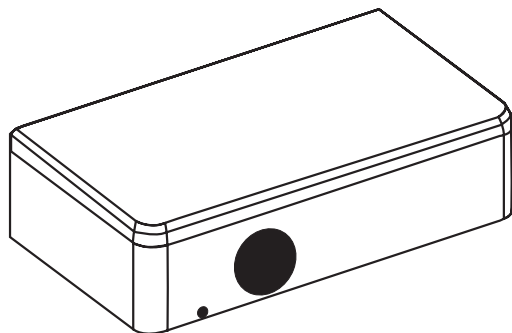

The battery management system (BMS) includes protection functions to guard against over-discharge, over-charge, over-current, and high/low temperatures. The system will automatically manage charging and discharging. The BMS manages and monitors information including voltage, current, and even the temperatures of the cells inside the battery. The BMS will balance the battery cells to maximize the energy that can be stored and recovered. Firmware and Wi-Fi connection are also built into the BMS. The BMS requires configuration to connect to the internet and will only connect to 2.4 GHz Wi-Fi .

The front of the Stack'd Series BMS shows an LED display that shows information relevant to the status of the system including State of Charge (SOC), State of Health (SOH), voltage, error codes, and more. Reference this chart to understand more pertaining to the status of your system. The power switch turns the entire system off.

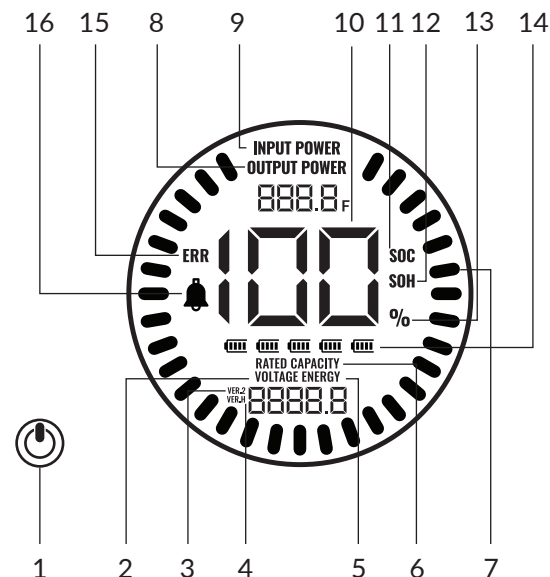

1	Power Switch	9	Charging Power
2	Current Voltage Level	10	Numerical Information
3	Software Version (Firmware)	11	Battery State of Charge (SOC)
4	Hardware Version	12	Battery State of Health (SOH)
5	Energy Throughput	13	Numerical Percentage
6	Capacity of all Modules	14	Number of Modules
7	Animated Streamline	15	Fault (Error)
8	Discharge Power	16	Alarm (Warning)

Stack'd Series BMS - Error Codes Reference Chart

An error code will only be displayed if a fault occurs. If the system is operating normally the error code will not be shown. The error codes are shown in the table below:

000	Normal	015	Cell failure
002	Low voltage protection	016	Failure
003	Charging over-current protection	019	External equipment communication fault
004	Discharge over-current protection	020	Internal equipment communication fault
005	Short circuit protection	022	Relay over temperature protection
006	Charging high temperatures	023	Copper bus over temperature protection
007	High discharge temperature	025	Lost communication between screen and device
008	Low charging temperature	051	Overcharge protection
009	Low discharge temperature	052	Over discharge protection
011	High ambient temperature	053	Low ambient temperature protection
013	Discharge circuit failure	054	MOS over temperature protection
014	Charge circuit fault		



When the system is charging, the display streamline gathers in the middle. When it is discharging the display streamline disperses to both sides.

Stack'd Series BMS - DIP Switches and Connectors

Uncovering the right-side panel on the BMS reveals multiple ports and DIP switches necessary for installation and communications with the inverter. Do not tamper with these switches or ports after a successful installation unless you are an electrician certified and authorized by HomeGrid, or you are guided to do so by our internal tech support team.

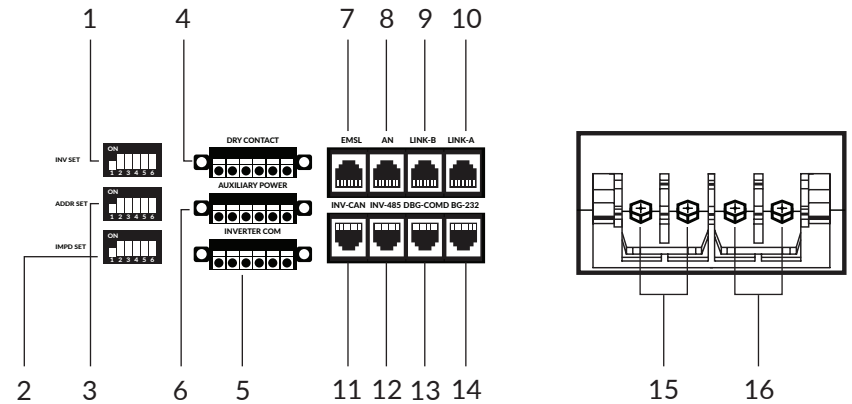

1	Inverter Protocol Selection Switch	9	Parallel Communication Port A
2	Imped. SET	10	Parallel Communication Port B
3	Controller Address Dial Switch	11	Inverter CAN Communication Port
4	Dry Contact	12	Inverter RS485 Communication Port
5	Inverter CAN/ RS485 Communication Port	13	CAN Upgrade Communication Port
6	Hall Current (Reserved)	14	RS232 Communication Interface
7	Reserved	15	Charge/Discharge Negative
8	Reserved	16	Charge/Discharge Positive

Stack'd Series 4.8 kWh Battery Module

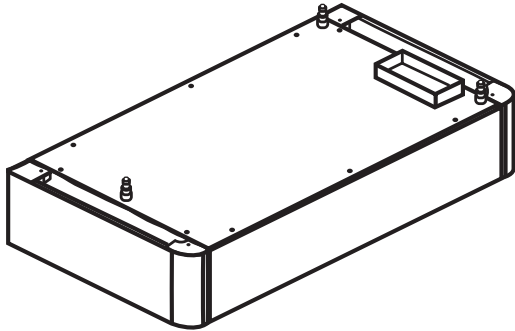

Beneath the BMS, you can stack 2-8 4.8kWh battery modules for a total capacity range of 9.6kWh to 38.4kWh. These battery modules are made from lithium iron phosphate (LiFePO4 or LFP), which is one of the safest lithium battery types.



For systems with multiple stacks (i.e., 2-15 stacks connected) all stacks must all be of equal capacity (i.e., same number of modules) for proper system configuration and operation.

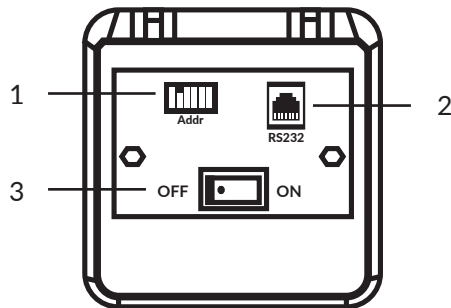

1	Address Dial Switch
2	RS232 Communications Interface
3	Power Switch

Behind the right-side panels of each battery module, you'll find access to a power switch, a row of dip switches and an RS232 port. Once your system has been fully configured and is operational, there should be no need to access or make changes in this section unless advised by HomeGrid Support for troubleshooting or making system configuration changes (i.e., expanding system).

Stack'd Series Base Stand

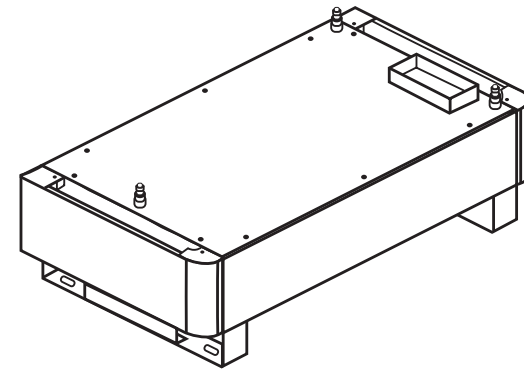

The base stand functions as a stand in which the battery modules can rest on. Additionally, the stand puts the battery modules 7.75 inches off the ground for protection.

ACTIVATION + SHUT OFF

Starting Up The System

Remove the side panels of the BMS and each module, displaying the **ON/OFF** switch for each individual battery module.

Starting with the very bottom module, turn **ON** each battery module from bottom to top.

Press the power button **ON**, located on the top BMS module (near the LCD display).

Safely ensure that solar power is coming through the inverter to supply power.

Shutting Down The System

Remove the side panels of each module, displaying the **ON/OFF** switch for each individual battery module.

Press the power button **OFF**, located on the top BMS module (near the LCD display).

Starting with the very top module, turn on each battery module from top to bottom.

Safely ensure that solar power is not coming through the inverter to the battery.

Emergency Response

In the event of any hazardous situation that poses a risk to health and safety, please adhere to the recommended procedures below:

For general emergencies:

- Immediately evacuate to a safe area
- Once it is safe to do so, contact 911 for immediate assistance

In case of flooding:

- Do not approach any battery module that is submerged in water as it may pose an electrocution hazard.
- If feasible and safe, drain the water in the area to protect your HomeGrid system.
- If water reaches the battery, contact your installer for inspection. If the water is below the battery, thoroughly dry the site of your HomeGrid battery system before use.

In case of fire:

- If possible, safely shut off the battery modules and BMS module using the Shutting Down procedure listed on page 16. Ensure that all solar power system components are shut off.
- Evacuate to a safe area.
- Contact 911 as soon as it is safe to do so.
- If it is safe, utilize approved fire extinguishing devices.

For warranty related questions, please see the Warranty Statement on page 7, or contact HomeGrid Support.

BACKUP OPTIONS

Depending on the design of the system, the HomeGrid Stack'd Series is able to partially or fully back up electrical circuits in small homes or even large commercial buildings. Described below are some general ways in which the HomeGrid Stack'd Series battery is electrically configured into the typical residential home for whole home, or partial home backup. Note that all scenario's described below involve an electrical grid connection, though connection to the electrical grid is not necessary for functional operation. Additionally, in all cases, "smart load management" equipment may be incorporated into these systems.

Whole Home Backup (Line Side Tap)

A line side tap allows for the direct connection of a solar power system to the electrical grid without passing through the main breaker panel. In this scenario, when off-grid, or during an electrical grid outage, the home's existing main breaker panel carrying all loads will be supplied power from the battery.

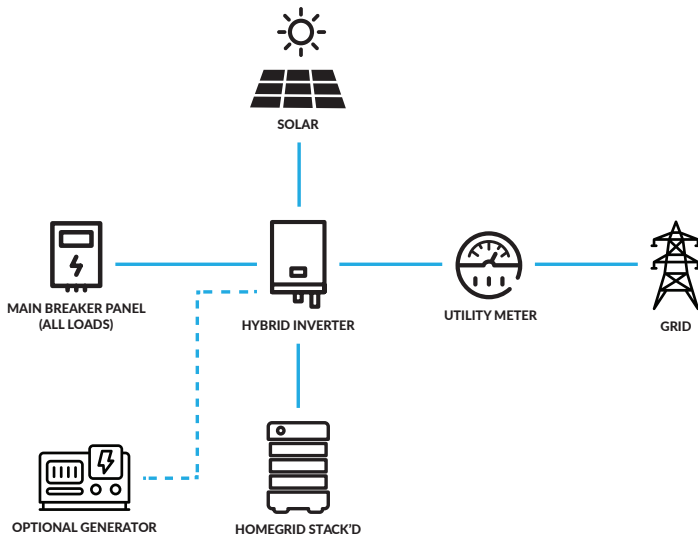

Whole Home Backup (Load Side Tap)

When a load side tap is used, the solar power system is connected to the electrical distribution system after the main breaker panel. Depending on the home's structure, this design may be necessary. In this case, another separate breaker panel is utilized within the solar system, carrying all the electrical loads in that home. In this scenario, when off-grid, or during an electrical grid outage, the additional main breaker panel carrying all loads will be supplied power from the battery.

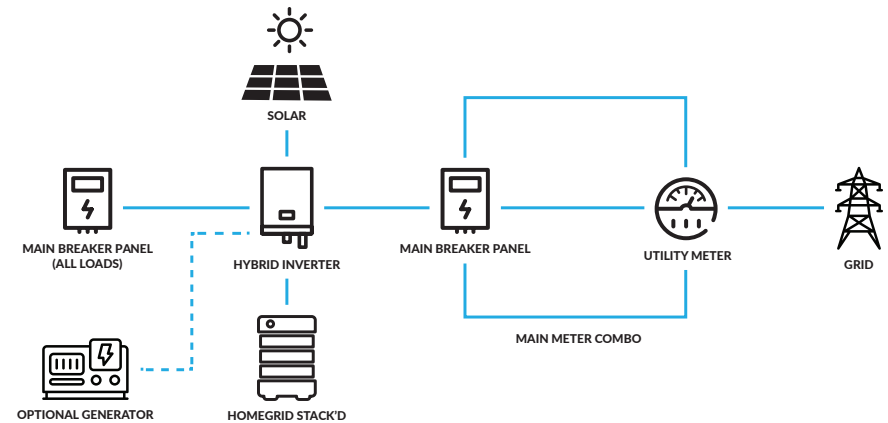

Partial Home Backup

If this configuration is selected, only the electrical loads in the home that are deemed necessary as critical loads will function in an off-grid scenario. This is done by moving those “critical” circuits from the existing main breaker panel into an additional breaker panel, often called a “critical load panel.” When operating the system off-grid, only those loads will be supplied power from the battery.

THE HOMEGRID ENERGY APP

The HomeGrid app offers remote monitoring capabilities for your HomeGrid Stack'd Series battery system. With the app, end users and installers can have remote access to detailed data about the system from anywhere.

On the HomeGrid app, you will find near real-time information from the battery, enabling you to stay informed about the operational status of your home power system. For detailed set-up instructions and additional information, please consult the HomeGrid Stack'd Series Installation Manual.

USER

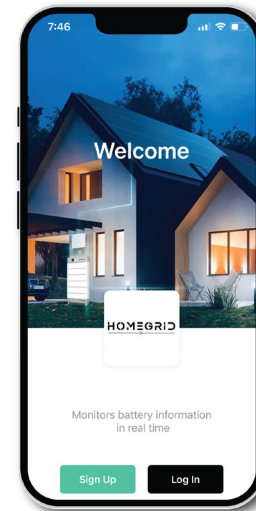

TROUBLESHOOTING

Common Questions + Solutions

What do I do if there is an Error 20 on the display?

- Check that the modules are addressed correctly (see pages 14-15).
- Check firmware is up to date.
- Confirm battery module detection was completed.

How do I get the BMS to communicate with a Sol-Ark inverter?

- Confirm the inverter communication cable is plugged into the INV-CAN port of the BMS and the battery CAN BUS on the inverter.
- If you didn't use our provided cable, please follow the pin guide on page 29 of the Install Manual when making your own inverter communication cable.

The display is not on, but the power button is on/pushed in.

- Firmware could be outdated or mismatched.
- Power cycle your first module, then power on the BMS.

How do I connect to the app?

- See the app section of the Install Manual (page 19)

What do I do if my batteries are flashing?

- Slow flash: Update the entire stack to the latest firmware.
- Fast flash: System needs to be balanced by discharging and charging to 100% SOC.

What do I do if there is an Error 15 on the display?

- There is cell damage on one of the cell packs. Call Tech Support for assistance.

What do I do if there is an Error 19 on the display?

- This is a parallel detection mode fault. If the system is in parallel, please check the communication cable between the master battery system and the connected battery systems in parallel.
- Set inverter DIP switches to parallel detection mode to rediscover the paralleled battery system.
- Set the parallel stack to the appropriate address (see pg 12 of the Install Manual).

What do I do if there is an Error 53 on the display?

- This is low ambient temperature protection mode. Raise the ambient temperature to above 5 °C.

What do I do if the battery icons on the display don't match the number of batteries I have?

- Put the BMS in detection mode.
- Confirm all modules are ON with a green light around the ON/OFF switch.
- Wait until the modules count matches the screen.
- Confirm the address of the modules are set according to the Install Manual page 11.

Technical Support

To obtain additional assistance, kindly reach out to your installer or the HomeGrid support team at support@lithionbattery.com, or call us at (855) 753-3505.

Before contacting HomeGrid directly, please ensure you have the following information readily available:

- Owner name and installer company name
- Preferred contact method (name, phone number, email)
- Serial numbers of your Stack'd Series BMS or Skybox (see figure below)
- Installation date
- A concise description of the issue you are experiencing

Stack'd Series Skybox Serial Number (for Gen 1-2)

Wireless Parameters

CMIIT ID: XXXXXXXXXXX (X)
 FCC ID: XXX-XXXXXXXX
SN/PIN: XXXXXXXXXXX/XXXXX
 Mac Address: XXXXXXXXXXXXXXX
 Wifi SSID: HG-EMS-XXXX
 Wifi Password: XXXXXXXX

Stack'd Series BMS Serial Number (for Gen 3+)

Stack'd Series Controller

Product Model: HG-XXXX-XXXX
 Product Spec: XXXX
 Max . Discharging Current: XXXX
 Operating Voltage: XX-XXXX



XXXXXXXXXXXXXXXXXXXXX